

WORLD SID-50M FITNESS ASSESSMENT IN FMVSS NO. 214 MOVING DEFORMABLE BARRIER AND OBLIQUE POLE CRASH TESTS

Whitney Tatem
Allison Loudon
NHTSA
USA

Paper Number 23-0340

ABSTRACT

A prerequisite for entering an anthropometric test device (ATD) design into the Code of Federal Regulations (CFR) Title 49, Part 572 is to demonstrate that the specifications yield units capable of implementation in a regulatory environment. Specifications for the WorldSID 50th percentile male (WorldSID-50M) ATD have produced units that are repeatable, reproducible, and durable in many test conditions, including qualification, sled, and crash testing. Herein, three WorldSID-50M units are implemented in a series of vehicle crash tests run in accordance with the Federal Motor Vehicle Safety Standard (FMVSS) No. 214 procedures, and evaluated based on usability, durability, and the successful collection of sensor data for use in injury risk prediction.

Methods and Data Sources: The National Highway Traffic Safety Administration (NHTSA) investigated WorldSID-50M performance in FMVSS No. 214 moving deformable barrier (MDB) and oblique pole tests. Performance metrics assessed included uniformity in periodic qualification testing during the crash test series, the durability of the ATD, successful collection of sensor data, and general usability. All qualification and crash tests were run at one lab with three WorldSID-50M units. Each ATD was the standard build level F with an in-dummy data acquisition system (IDDAS) setup (DTS G5 units), a RibEye Multi-Point Deflection Measurement System, thorax pads, modified shoulder pads, and a sleeveless suit. Before the test series, each ATD was fully qualified per NHTSA's WorldSID 50th Percentile Male Qualification Procedures Manual, and additional qualification tests were conducted throughout the crash series. Eighteen crash tests (seven MDB and eleven oblique pole) with model year 2019 and 2020 vehicles were ultimately conducted.

Results: The three WorldSID-50M units met qualification test requirements throughout the crash test series with minimal issues. Results were within performance specifications after tightening loose bolts in the upper and lumbar spine prior to being used in the crash tests. The WorldSID-50M Dummy Seating Procedure was followed and resulted in repeatable and reproducible seating positions. In crash tests, the WorldSID-50M ATDs were durable and successfully collected sensor data. Apart from a broken ankle in one test, no permanent damage was seen on any ATD. One pole test resulted in loss of the maximum thorax rib deflection due to a RibEye LED blockage by another rib. The issue was resolved by relocating the rib's LEDs. The WorldSID-50M posed no other difficulties in performing the crash tests.

Conclusion and Limitations: This controlled study of the WorldSID-50M in FMVSS No. 214 testing showed that the ATD is durable and successfully collects sensor data in both qualification and crash testing. There were few sensor anomalies throughout the test series, and any instrumentation issues were quickly resolved. Collectively, this series of crash tests demonstrates that the design of the WorldSID-50M appears robust and provides a tool suitable for use in standardized side impact testing. A limitation of this study is that all tests were conducted at a single lab. Further, few small, compact, and sub-compact size vehicles were included in this test series. Additional analysis of data from ongoing crash tests encompassing a more comprehensive vehicle fleet will yield more holistic results assessing the WorldSID-50M.

INTRODUCTION

NHTSA has performed research tests using an advanced side impact ATD, the WorldSID-50M, since 2005. This ATD is an alternative to the ES2re, where the WorldSID provides better biofidelity (quantitatively shown using NHTSA's Biofidelity Ranking System) and enhanced injury assessment capability [1]. To date, the WorldSID-50M has been assessed in over 70 crash tests and 1,800 component-level tests to refine the ATD design.

For an ATD design to be entered into CFR Title 49, Part 572¹, the specifications must yield units capable of implementation in a regulatory environment. In December 2015, NHTSA issued a Request for Comments (RFC) that included implementing the WorldSID-50M into current New Car Assessment Program (NCAP) side test protocols [2]. Subsequently in 2016, NHTSA conducted a series of research crash tests including nine NCAP MDB tests and nine FMVSS No. 214 oblique pole tests using the then current version of the WorldSID-50M². Further, in 2019, NHTSA conducted repeatability and reproducibility (R&R) tests at three crash labs including both NCAP MDB and FMVSS No. 214 oblique pole tests with a 2018 Honda Accord and the WorldSID-50M³. The WorldSID-50M has additionally been utilized in qualification and sled testing environments to evaluate R&R [3] and durability [4]. RibEye performance was evaluated in linear impactor, sled, and crash conditions [5]. During all series of testing, the WorldSID-50M seating procedures, test procedures incorporating the IDDAS, and the RibEye were evaluated and updated, among others, as appropriate.

NHTSA recently announced its intent to enter the WorldSID-50M into CFR Title 49, Part 572 (RIN: 2127-AM22) and subsequently into FMVSS No. 214 as an ATD option (RIN: 2127-AM23). Considering that updates to the WorldSID-50M design and associated procedures have been made since the RFC in 2015, the objective of this research was to evaluate the latest version of the WorldSID-50M based on usability, durability, and the successful collection of sensor data when exposed to qualification tests and FMVSS No. 214 MDB and oblique pole crash tests.

METHODOLOGY

Overview

NHTSA conducted a series of eighteen full-scale vehicle crash tests from September 2020 through June 2022 that epitomizes the WorldSID-50M envisioned use in a regulatory setting – a crash test series of FMVSS No. 214 MDB and oblique pole tests including qualification tests. Ten distinct 2019-2020 model year vehicles were used in testing: the Chevrolet Malibu, Ford Ranger, GMC Terrain, Hyundai Santa Fe, Hyundai Veloster, Kia Soul, Mini Cooper S convertible, Nissan Rogue, Ram 1500, and Toyota Tacoma. Details of the tests are discussed below.

FMVSS No. 214 Tests

The eighteen crash tests were run by following FMVSS No. 214 procedures for either the driver (for left-side vehicle impacts) or the front passenger (for right-side vehicle impacts). For reference, the FMVSS No. 214 crash configurations are depicted in Figure 1. Eleven pole tests were conducted in accordance with the latest FMVSS No. 214 test procedure, TP-214P-01, dated September 2012. The first test of the series was conducted with a higher NCAP target test speed of 32.2 ± 0.8 km/h. Following this test, all the remaining ten pole tests were run at the compliance target test speed of 31.0 ± 0.9 km/h. Seven MDB tests were conducted in accordance with the latest FMVSS No. 214 test procedure, TP-214D-09, dated September 2012, and all run at the compliance target test speed of 52.9 ± 0.8 km/h⁴.

¹<https://www.ecfr.gov/current/title-49/subtitle-B/chapter-V/part-572?toc=1>

²<https://www.nhtsa.gov/research-data/research-testing-databases#/vehicle> [Test Numbers 9780-9791, 10051-10056]

³https://www.nhtsa.gov/sites/nhtsa.gov/files/documents/nhtsas_rr_evaluation_of_the_wordsid_50th_male_atd_tag.pdf

⁴ <https://www.nhtsa.gov/vehicle-manufacturers/test-procedures>

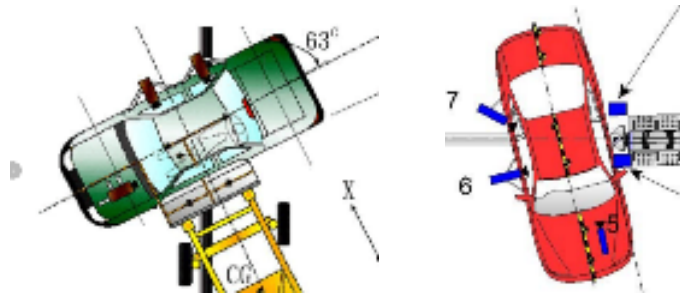

Figure 1. (L) Impact by the MDB, and (R) oblique impact with the rigid pole.

In all tests, the WorldSID-50M was positioned per the WorldSID 50th Percentile Male Dummy Seating Procedure Evaluation and Revision [6]. Performance metrics assessed included uniformity in periodic qualification testing during the crash test series, the durability of the ATD, successful collection of sensor data, and general usability.

WorldSID-50M Units Tested

During this test series, three different WorldSID-50M ATDs were used, all conforming to NHTSA's WorldSID-50M design specifications. Each unit was manufactured by Humanetics in accordance with NHTSA's Parts List and Drawings [7]. The WorldSID-50Ms were also notably equipped with a Diversified Technical Systems, Inc. (DTS) G5 IDDAS, a RibEye Multi-Point Deflection Measurement System, thorax pads, modified shoulder pads, and a sleeveless suit.

All ATDs were instrumented and assembled (including wire harness routing and instrumentation polarity checks) at NHTSA's Dummy Management Laboratory (DML) at the Vehicle Research and Test Center (VRTC) in Ohio prior to delivery to the crash test lab, Transportation Research Center, Inc. (TRC). Final inspections, setup (including joint torque settings), and qualification tests [8] were fulfilled at TRC by following NHTSA's WorldSID-50M Procedures for Assembly, Disassembly, and Inspection (PADI) [7].

Two WorldSID-50M units were configured for left side impacts while the third was configured for right side impacts. They will henceforth be referred to as WS-L1, WS-L2, and WS-R, respectively. Each ATD was instrumented with head accelerometers, head angular rate sensors, upper and lower neck load cells, shoulder load cells, T1/T4/T12 accelerometers, lumbar load cells, pelvic accelerometers, pubic load cells, left and right sacroilia load cells, and femur/femoral neck load cells. All these instruments are specified within the drawing package, with installation instructions included in the PADI [7]. Additionally, all units were instrumented with sensors to measure the internal ATD temperature before, during, and after testing.

WorldSID-50M Configurations

DTS G5 In-Dummy Data Acquisition System (IDDAS)

The WorldSID-50M contains provisions for IDDAS up to 128 channels depending on the specific configuration, and the DAS units can be installed in a variety of locations throughout the ATD thorax, pelvis, or upper legs. The design used in this test series utilizes the two 32-channel DTS G5 IDDAS installed in the thorax/spine for a quantity of 64 channels. In addition, the ATDs are also equipped with a separate IDDAS controller for the RibEye system that is installed on the non-struck side of the spine box.

RibEye Multipoint Deflection Measurement System

RibEye, manufactured by Boxboro Systems⁵, is a multipoint optical measurement system that is capable of measuring 3D rib deflection at multiple points on each of the six independent ribs of the WorldSID-50M. The RibEye consists of two groups of three sensors (receivers) mounted on the impact-side of the spine box, one at each rib level, as depicted in Figure 2(a). On the opposite side at each rib level are three LEDs per rib, mounted on the

⁵ <https://www.boxborosystems.com/ribeye.html>

inner surface of the inner rib, as shown in Figure 2(b). The LEDs are mounted at front, middle, and rear locations on each rib, spaced at 35 mm apart, as determined by an optimization study [9] (Figure 3). Further, each LED has a specific mounting method, vertical position, orientation, and an angle for positioning on the ribs [7]. This combination of optical sensors and LEDs makes RibEye capable of measuring both lateral and oblique rib deflections, a distinct advantage over other systems such as the IR-TRACC, when the ATD is subjected to the oblique loading that sometimes occurs in side impacts.

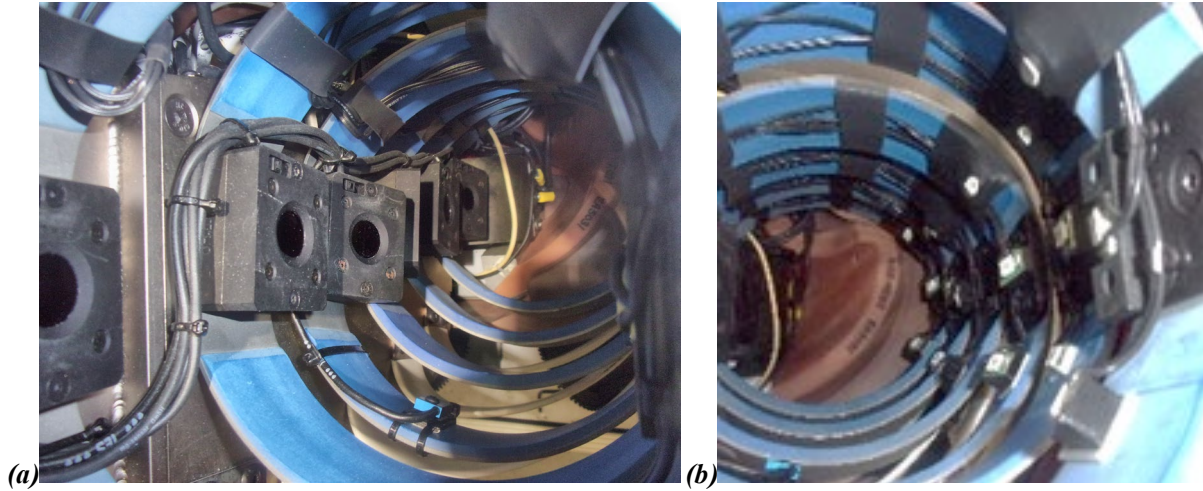

Figure 2. RibEye sensors (a) and LEDs (b) installed in a WorldSID-50M.

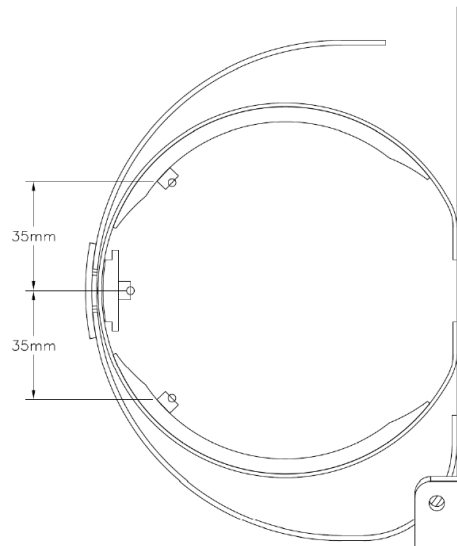

Figure 3. Schematic showing front, middle, and rear RibEye LED locations on a WorldSID-50M rib.

Given that RibEye is a novel optical measurement system, there are some distinct and notable traits when compared to other systems. Each sensor on the RibEye has a finite measurement range, so if an LED moves outside the detectable range, its position cannot be measured. When this occurs, the RibEye system produces an ‘error code’ indicating as such. From previous tests conducted by NHTSA, LEDs going out of range are often inconsequential if at least one LED on a rib does not exceed the range of the sensor. An error code is also produced when one or more sensors are blocked from the LEDs or if too much ambient light is detected by a sensor. An example of this is when one rib deflects more than an adjacent rib, blocking the path from an LED to a sensor. When this situation occurs, the rib with the most deflection is often measured, rendering the blocked LED insignificant.

Thorax Pads

The original WorldSID-50M build has a single thorax pad between the outside of the ribs and jacket. Because NHTSA witnessed these pads tearing during evaluation testing, it was thought that it would be beneficial to split the single pad into pads for each individual rib as depicted in Figure 4(a). The split pad design was used in the first sixteen crash tests of this series. In parallel, a new probe face was developed within the ISO WorldSID 50th Task Group for qualification testing. This development proved to significantly reduce the risk for tearing of the single thorax pad during qualification tests, which had been impetus for developing the split pad concept. With the new probe face greatly alleviating pad durability concerns, NHTSA chose to revert to the original one-piece thorax pad as depicted in Figure 4(b), harmonizing with the ISO group. The last two tests of the series were conducted with this single pad design.

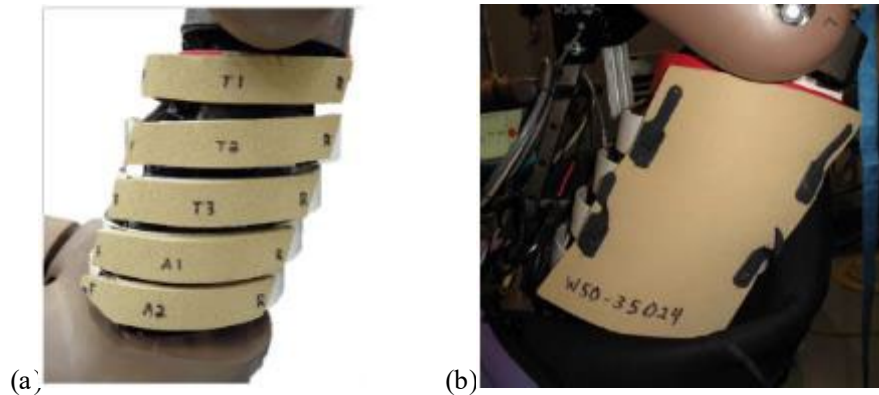

Figure 4. WorldSID-50M (a) split and (b) single thorax pads.

Shoulder Pads

The original design of the WorldSID-50M shoulder pad by Humanetics was a soft vinyl and foam pad. During testing in 2016 with the original foam shoulder pad and RibEye, it was observed that the shoulder pad would protrude into the shoulder rib cavity during impact causing shoulder LED blockages. Therefore, prior to this series of testing, a new shoulder pad designed by VRTC (Figure 5) with a similar footprint but hollowed-out underside, with stiffening qualities that prevent it from being pushed into the shoulder rib cavity of the ATD was developed, tested, and evaluated by NHTSA in the 2018-2019 R&R crash test series.

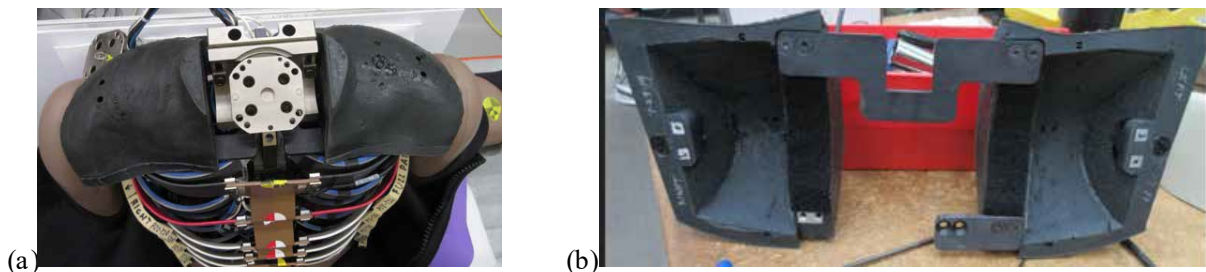

Figure 5. Top (a) and bottom (b) view of VRTC's prototype WorldSID-50M shoulder pad design.

For this crash test series, in the first few crash tests, VRTC's prototype design was used with a screw attachment at the shoulder rib. However, during the test series, it was noted that the aluminum screw mounting blocks molded into the shoulder pads were tearing out of the pads during testing. Therefore, the design was modified mid-series with a minor change where the screw was replaced by a single pin at the shoulder rib clamp. This new design was implemented to improve the ease of use of the shoulder pads, along with improving the durability of the shoulder pads.

Sleeveless Suit

The original WorldSID-50M skinsuit included sleeves for the arms and contained a sizeable hole under the arm to facilitate arm motion. However, in this configuration, the sleeve fabric could bunch together during shoulder flexion and the hole provided a path for external light to enter the thoracic cavity, potentially interfering with the RibEye functionality. Therefore, a sleeveless skinsuit design has been adopted by NHTSA as depicted in Figure 6. The sleeveless suit provides improved freedom of arm motion without bunching and eliminates the potential light path under the arm.



Figure 6. WorldSID-50M dressed in its sleeveless skinsuit.

WorldSID50-M Qualifications and Inspections

Prior to the initial vehicle crash test for each WorldSID-50M, a full set of qualification tests was conducted at NHTSA's DML at VRTC or at TRC (Appendix A details the qualification location). Thereafter, a full set of qualification tests were conducted at TRC after every third crash test. Partial qualification tests were conducted after some vehicle crash tests on the WorldSID-50M units if there were instrumentation issues or dummy damage at both VRTC DML and TRC DML. All qualification tests were carried out in accordance with NHTSA's draft WorldSID-50M Qualification Procedures [8]. Additionally, before every qualification test, a polarity check and sensor checkout were performed to assure that all sensors were oriented and working properly.

After every crash test, the tested WorldSID-50M unit underwent a physical inspection. Each body region was examined by partially disassembling the ATD, and a visual inspection was carried out. Photographic images of any damage are documented in each test report.

As part of the inspection, each ATD sensor was scrutinized for its overall condition and functionality. This was determined by examining crash test signal data channels for any sensor anomalies, such as clipping, unexpected drops, or flat signals. Instruments were also inspected for any physical evidence of damage. If damage was found, the instruments were closely inspected to determine the source of the anomaly and repaired where possible.

Crash Test Exposures and Schedule

For the two FMVSS No. 214 test modes (MDB and oblique pole), the three WorldSID-50M units were subjected to multiple crash exposures as shown in Table 1. Each test type exposed the ATD to a different loading condition. Multiple tests were run in each condition to assure the ATD was thoroughly exercised in each exposure mode.

Table 1. WorldSID-50M crash test exposures (n = 18).

NHTSA Test #	Test Date	Vehicle Model Year	Vehicle Make	Vehicle Model	Test Type	WorldSID-50M Unit
Primary Testing Series						
11600	9/25/2020	2019	Chevrolet	Malibu	L Pole	WS-L1
11601	10/22/2020	2020	Nissan	Rogue	L Pole	WS-L1
11603	12/15/2020	2020	Hyundai	Santa Fe	L Pole	WS-L1
11604	1/14/2021	2020	Hyundai	Veloster	L Pole	WS-L1
11605	1/28/2021	2020	Hyundai	Santa Fe	L MDB	WS-L1
11606	2/4/2021	2020	GMC	Terrain	L MDB	WS-L1
11607	2/11/2021	2020	Hyundai	Veloster	L MDB	WS-L1
11608	3/11/2021	2020	Nissan	Rogue	L MDB	WS-L1
11609	3/18/2021	2020	Ford	Ranger	L MDB	WS-L1
11610	3/23/2021	2019	Chevrolet	Malibu	L MDB	WS-L1
11611	4/1/2021	2020	GMC	Terrain	L Pole	WS-L1
11612	4/8/2021	2020	Ford	Ranger	L Pole	WS-L1
11613	4/15/2021	2019	Ram	1500	R Pole	WS-R
11614	4/22/2021	2019	Mini	Cooper S Con.	R Pole	WS-R
11615	4/29/2021	2020	Mini	Cooper S Con.	R MDB	WS-R
Secondary Testing Series						
11656	9/15/2021	2019	Mini	Cooper S Con.	R Pole	WS-R
14356	6/8/2022	2020	Toyota	Tacoma	L Pole	WS-L2
14355	6/15/2022	2020	Kia	Soul	L Pole	WS-L2

All crash tests were run at TRC per the schedule of testing summarized in Table 1. The eighteen tests were run between September 2020 and June 2022, with five- and nine-month gaps between April to September 2021 and September 2021 to June 2022, respectively, in which no testing was performed due to RibEye LED enhancement efforts, which are discussed subsequently.

A NHTSA test number is denoted for each test, from which test reports may be found by searching within NHTSA’s Crash Test Database⁶. Each report provides all test signals from the crash tests. It also includes the pre- and post-test qualification testing results performed on each of the WorldSID-50M units, as well as a post-test inspection of the ATD. NHTSA Test numbers 11600–11615 are henceforth referred to as ‘the primary testing series,’ while numbers 11656, 14356, and 14355 are referred to as ‘the secondary testing series.’

WorldSID-50M Injury Assessment

Injury Assessment Reference Values (IARVs) typically refer to the limits for a given injury criterion calculated based on crash test results. For regulatory purposes, IARVs are defined in the regulation that describes the crash test modes, such as FMVSS No. 214. The WorldSID-50M does not currently have specified IARVs. Therefore, for the purpose of this research paper, a set of baseline comparative values were selected for the purposes of the current study.

To guide the selection of baseline values, existing injury criteria specific to the WorldSID-50M were referenced. Generally, reference values were selected based on current European NCAP metrics with the addition of BrIC, as displayed in Table 2.

⁶ <https://www.nhtsa.gov/research-data/research-testing-databases#/vehicle>

Table 2. WorldSID-50M EuroNCAP reference values for injury assessment.

Body Region	Criterion / Measurement	Units	EuroNCAP Reference Value
Head	HIC15	none	700
	BrIC	none	0.96
Chest	Shoulder Force	N	3,000
	Thoracic Rib Deflection	mm	50
Abdomen	Abdominal Rib Deflection	mm	65
Pelvis	Pubic Force	N	2,800

RESULTS AND DISCUSSION

Qualification Tests

Each WorldSID-50M was fully qualified before the test series, and additional qualifications (some full, some partial) were conducted throughout the test series as described below (see Appendix for a full test summary). All qualifications were performed and processed according to the Draft NHTSA WorldSID-50M Qualification Manual [8], and the corridors contained therein.

WS-L1

From September 2020 to April 2021, WS-L1 went through six full qualifications. In five of the six full qualification tests, the WorldSID-50M passed in its entirety. During the fourth qualification, which occurred after test 11607, the WorldSID-50M did not initially pass the thorax with a arm test. After some troubleshooting, an inspection revealed loose bolts on top of the spine box which were simply tightened to remedy the failure. It is unclear at what point these bolts began coming loose since full qualification tests were only being performed after every third crash test. The bolts were tightened and the thorax with a arm test was conducted again resulting in a passing test.

WS-R

From January 2021 to April 2021, WS-R went through two full qualifications. During the first full qualification test, the WorldSID-50M did not pass the thorax with a arm test in its initial impacts. After several additional attempted thorax with a arm tests, inspection revealed there were loose bolts that connect the lumbar mounting wedge to the rubber lumbar spine. Again here, simply tightening the bolts remedied the failure. It is unclear when the bolts began to loosen due to different troubleshooting methods executed by VRTC and TRC (e.g., replacing ribs and additional qualifications).

The post-primary-test-series qualification (the second full qualification), which occurred after test 11615, passed all test modes except for the pelvis. The lateral sacroiliac force result was low (1812 N) compared to the draft specification of 1860-2280 N. Because this was a post-series qualification, the test result was documented and accepted.

However, during the secondary test series pre-test qualifications (the third full qualification), there were additional difficulties in attaining passing results on the pelvis qualification test mode. After four attempts, the pelvis results not meeting the proposed criterion were accepted due to this being a newly proposed criterion. While a high impactor force was encountered in one of the attempts, the primary failing parameter was the sacroiliac lateral force, which was consistently low. This result was like the result in the second full qualification.

Following crash test 11656, the fourth full qualification was performed. WS-R underwent troubleshooting and additional testing to resolve the pelvis issues. Prior to any tests being performed, the rubber lumbar component was replaced as a first attempt to remedy the problem. The tests that followed no longer exhibited any abnormalities with the sacroiliac force; however, the new issue became low pubic force responses. Multiple parts were swapped out and tested to identify the cause of these issues. At the time of manuscript preparation, these issues are still unresolved, and investigation is ongoing.

WS-L2

Due to the pelvis issues discussed in WS-R, a third WorldSID-50M unit was introduced, WS-L2. In May 2022, a full qualification was performed with passing results prior to the last two oblique pole crash tests (14355 and 14356). A full post-test qualification was conducted in July 2022, and the ATD passed all test modes.

Seating Procedure

The WorldSID-50M seating procedure was followed to position the ATD in each crash test. The procedure places the seat pan at a mid-angle, at the lowest height position, and typically at midtrack, barring any lower body interference with the trim panels of the vehicle dashboard. Among the vehicles used in the test series, a 2019 Mini Cooper S convertible was used more often than the other vehicle models. A WorldSID-50M unit was seated in the front passenger seat in three Mini Cooper tests. Figure 7 displays a stick figure derived from the Mini Cooper vehicle reports that indicates the relative uniformity of the ATD positioning (WorldSID-50M unit WS-R in all cases). It shows the x- and z-coordinates relative to the door lock striker on the passenger side of the vehicle. Coordinates of high interest are shown in the figure, including the outboard H-point.

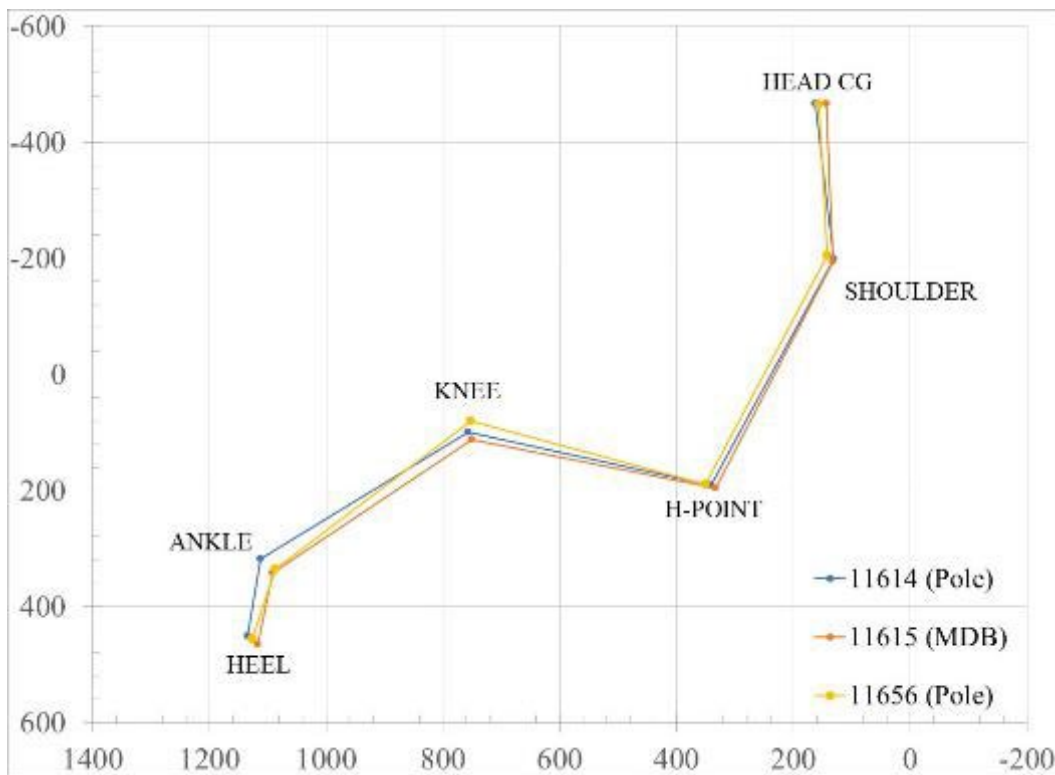

Figure 7. WorldSID-50M Front Passenger: Seated coordinates in three Mini Cooper S convertible tests.

Oblique Pole Tests

All the seats were able to be positioned at midtrack without any interference with the vehicle interior in all eleven oblique pole tests. The seating procedure specifies tilt sensor ranges (± 2.5 degrees) for both the pelvis and head position along with an H-Point target location range of ± 10 mm. The Ford Ranger driver test position was the only test where the neck was adjusted out of the zero-degree position. In this test, the neck was adjusted 3 notches, rotating the chin upward. On average, in the oblique pole tests, the measured position of the H-point was -0.2 mm rearward and 5.4 mm below the projected H-point. There were no major issues with seating the ATDs in the pole tests, though there were a few deviations or noteworthy observations that are detailed in the sections below.

MDB Tests

The seats were able to be positioned at midtrack without any interference with the vehicle interior in six of the seven MDB tests. On the Nissan Rogue MDB test, the knees of WS-L1 were meeting the underside of the dash, leading to the seat being placed rearward of midtrack – this is discussed in further detail below. The GMC Terrain MDB test was the only test where the neck was adjusted out of the zero-degree position – on this test, the neck was adjusted 1 notch, rotating the chin upward. On average, in the MDB tests, the measured position of the H-point was 0.2 mm rearward and 5.7 mm below the projected H-point. There were no major issues with seating the ATDs in the MDB tests, though there were a few deviations or noteworthy observations that are detailed in the sections below.

Foot Placement

The seating procedure was developed to help place the WorldSID-50M feet in a similar manner in a variety of vehicles, with the right foot placement based on pedal type and the left foot dependent on the presence of a footrest and if it elevated the heel.

Right Foot

Throughout the test series, the heel point was marked at 200 mm from the pedal center point depending on the type of pedal (hinged or hanging). For many tests, the right foot was within the range established of +/-10mm in the fore/aft position. It was not always clear if the heel point was taken based on the center of the shoe. When comparing right foot placement in the GMC Terrain MDB and pole tests, it was noted that the right heel point for the MDB test was incorrectly established using 250 mm from the pedal center point instead of the 200 mm distance specified in the seating procedure. Because of this, the right heel was positioned roughly 40 mm rearward from where the right heel was positioned in the GMC Terrain pole test.

Left Foot

Throughout the test series, the left foot was often positioned in such that it was only partially on the footrest. On two (Chevrolet Malibu and Hyundai Veloster) of the six left-side pole tests and on three (Hyundai Santa Fe, Chevrolet Malibu, and Ford Ranger) of the six left-side MDB tests, the left foot was placed so that the foot was partially on the footrest.

In discussing this with the test lab, their interpretation of the seating procedure was that the foot did not need to be positioned so that it was completely on the footrest. They either misinterpreted the equidistant spacing marking based on the centerline of the seat and the right foot placement, which would make the foot sit partially on the footrest, or the ATD ankle structure prevented the foot from fully engaging with the footrest. Because of these scenarios, NHTSA is investigating the section of the seating procedure dealing with the placement of the left foot.

Temperature Control

According to NHTSA's Qualification Procedures and for FMVSS No. 214 crash testing, the temperature of the WorldSID-50M must be soaked in a controlled environment that is 20.5-22.2 C (69-72°F) and has a relative humidity from 10-70% for at least four hours prior to a test. The IDDAS, RibEye, and trigger systems all produce heat when active and thus can increase the internal temperature of an ATD, especially when operating simultaneously. The damping material that covers the ribs is particularly sensitive to temperature, so the internal temperature of the WorldSID-50M ATDs were monitored on test day. Per the Qualification Procedures, the ribs shall not reach a temperature higher than 23.9 C (75° F) [8]. The WorldSID-50M ATDs had temperature sensors installed on top of the RibEye controller (non-struck side) and on the thorax rib 2 damping material near the spine box (impact side).

Indeed, elevated rib temperatures were observed in the first three crash tests of this series. There were a few instances where the rib temperature was close to exceeding or did exceed the established upper temperature threshold of 23.9 C. One such test, 11601, in which the rib temperature was slightly elevated at the time of the crash is shown in Figure 8. The black solid line is the ambient temperature of the lab, the solid blue line is the temperature on the RibEye DAS, and the blue dashed line is the temperature of the second thorax rib (impact side). The final

switching 'ON' of the DAS unit in this test occurred ~2:15pm, and the RibEye controller and rib temperatures began to rise. At the lab where the tests occurred, the doors to the setup lab were opened prior to the test, which occurred just after 3:00pm. The colder external air temperature slightly cooled the ATD between bay door opening and firing of the test, but overall temperatures remained elevated due to the DAS. The WorldSID-50M rib temperature at the time of the crash was over the limit by 0.4°C.

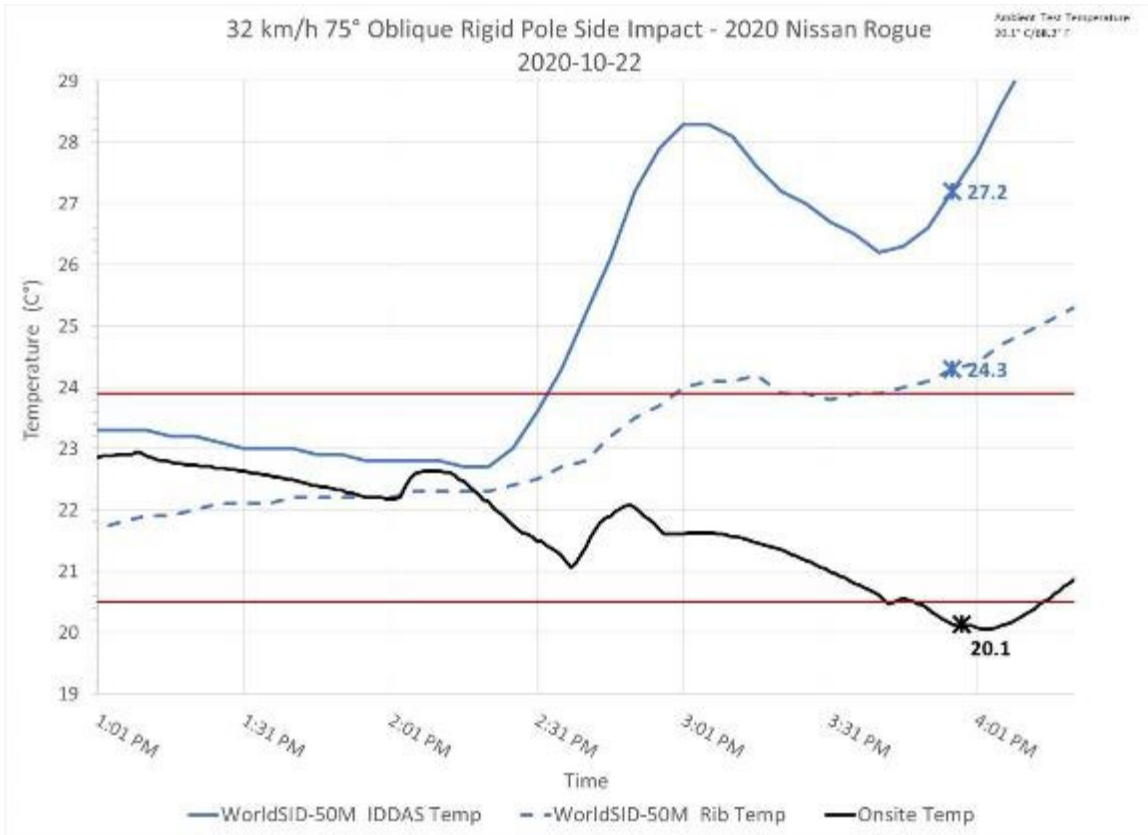

Figure 8. WorldSID-50M Rib Temperature Timeline for Crash Test 11601.

Without any countmeasures, when the temperature exceeds the limit, it is advisable to delay the test until the temperature drops back below the threshold, if feasible. To reduce the amount of time needed for the WorldSID-50M to cool down, and to prevent it from overheating in the first place, a fume extractor⁷ was used in many of the remaining crash tests to cool and maintain the internal ATD temperature pre-crash, as depicted in Figure 9. This device provides air movement, forcing the hot air out of the ATD via a suction hose that is easily inserted into the suit opening below the abdomen ribs. Subsequently, cool ambient air is pulled through existing openings in the suit around the neck and arms, over the spine box, RibEye controller, and ribs.

⁷ Weller Fume Extractor

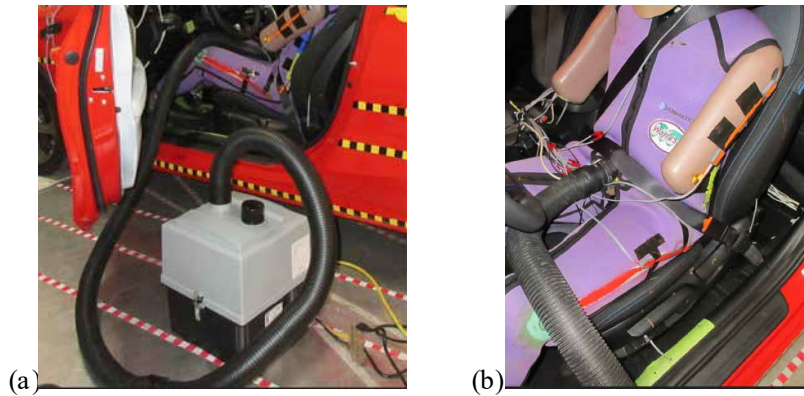

Figure 9. The implemented ATD fume extractor, shown (a) outside of a test vehicle and (b) with its connection to the WorldSID-50M.

The Hyundai Veloster pole test, 11604, was the first test that the fume extractor was used in to cool down the WorldSID-50M following trigger check. It was extremely effective in cutting down the time required for the ATD to cool down. On subsequent tests, including 11606 as seen in Figure 10, the fume extractor was implemented whenever there was any sort of delay with the ATDDAS turned on. As displayed in Figure 10, the final switching ‘ON’ of the DAS unit occurred ~3:37pm, and the fume extractor was activated ~4:00pm. This prevented the rib temperature (dashed blue line) from exceeding the limit, also preventing any additional temperature related delays. Throughout the remainder of the test series, this device demonstrated good effectiveness at reducing the WorldSID-50M internal temperature in a short period of time.

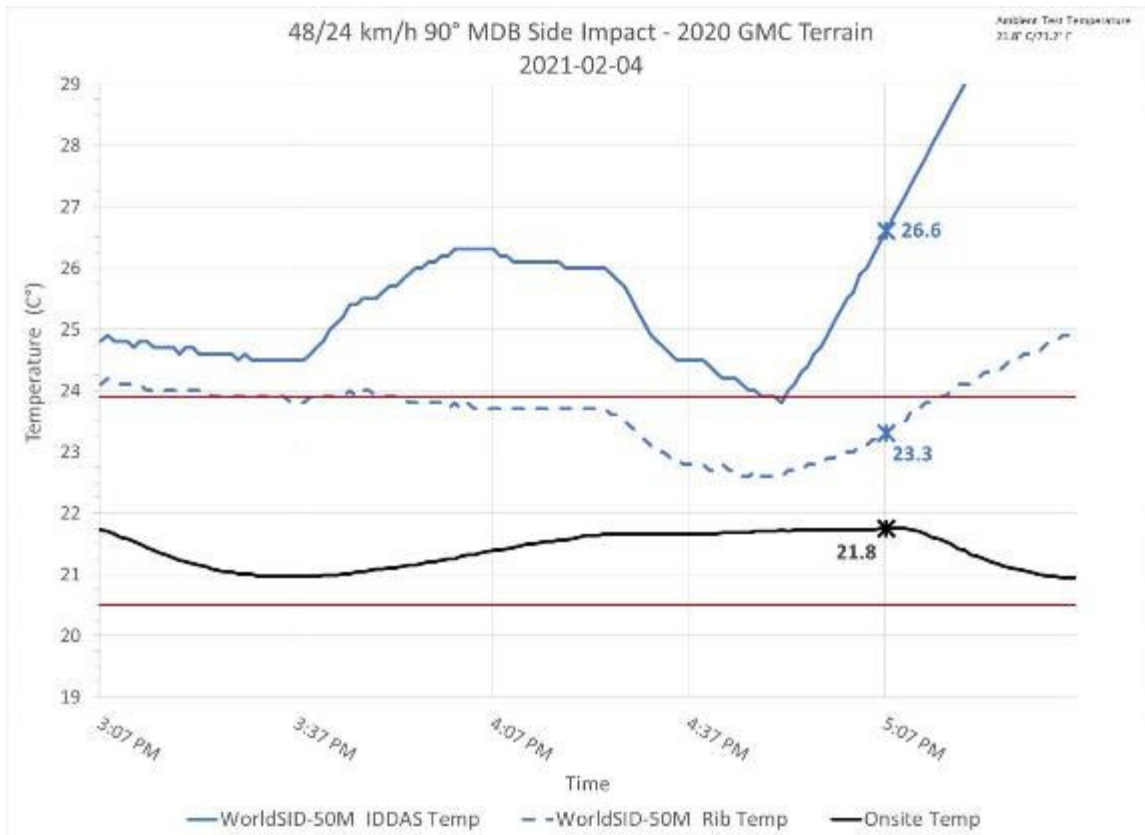

Figure 10. WorldSID-50M Rib Temperature Timeline for Crash Test 11606.

It is notable that if the IDDAS, RibEye, and trigger systems are tested the day before a crash test and there are no system issues the day of the test, the WorldSID-50M can generally be kept within the target temperature range without the use of a fume extractor. The test lab was routinely able to maintain the appropriate WorldSID-50M temperature range without the need for a fume extractor by limiting the "ON" time of the IDDAS units.

Durability

The WorldSID-50M was inspected after each crash test for damage. Throughout the crash test series and qualifications, none of the WorldSID-50M units sustained irreparable breakage. There were a few part repairs and/or replacements as enumerated below.

RibEye Multipoint Deflection Measurement System

During the first few crash tests (11600-11603 and 11605), there were some intermittent LED signals, which could have stemmed from how the wiring harness was installed and manufactured. While WS-L1 was undergoing its fourth set of qualification tests, which occurred after eight crash tests (when the loose bolts on top of the spine box were identified), loose LED connector pins were found. Following inspection of all RibEye connectors and discussion, all the LEDs and their connector pins were ultimately replaced in a new manufactured wiring harness. Additionally, a partial qualification was conducted on the body to verify that changing the LEDs resulted in similar responses prior to the swap. It was also noted that the shrink wrap around the LEDs may need to be checked periodically to identify loose or broken connections at the LED.

During the final post-test inspection of WS-L1 (after the thirteenth crash test, 11612), it was found that the rear LED on the left abdomen 2 rib had become detached from its mount. This was fixed by simply gluing it back in place.

Shoulder Rib Stiffeners

After the first crash test, the WorldSID-50M shoulder rib stiffeners were found to be bent. This damage had also been observed during a previous WorldSID-50M R&R crash test series in 2019. New, undeformed stiffeners lay flush against the outer shoulder rib band, but post-test there was a gap between the rib band and stiffeners. Despite this deformation, the WorldSID-50M passed shoulder and thorax with arm qualification tests, so the next crash test proceeded with the bent stiffeners. The stiffeners were however replaced during the next set of qualification tests after crash test 11601. Following the replacement, it was decided that if the ATD continued passing qualifications, the rib stiffeners would not continue to be replaced unless there was significant damage.

Ankle Z-Axis Radial Limit Screw

In both GMC Terrain tests, 11606 and 11611, the right foot of WS-L1 was found after the test to have rotated significantly about its Z-axis as depicted in Figure 11(a). Upon closer inspection, it was found that the z-axis radial limit screw had been sheared as shown in Figure 11(b). Visually inspecting the footwell, there were no unusual characteristics that stood out as possible causes of the damage. A high-speed camera was placed in the footwell on the GMC Terrain pole test (11611), and subsequently on the Ford Ranger pole test to gain a better understanding of the foot interaction through the impact event. It appears that the foot engages the brake pedal of the GMC Terrain a bit more behind the face of the pedal compared to how it engages with the Ford Ranger's brake pedal. It is possible that this allows the foot to roll off the Ranger's brake pedal before enough force builds up to shear the bolt, whereas the Terrain's brake pedal does not allow for a similar motion to occur.

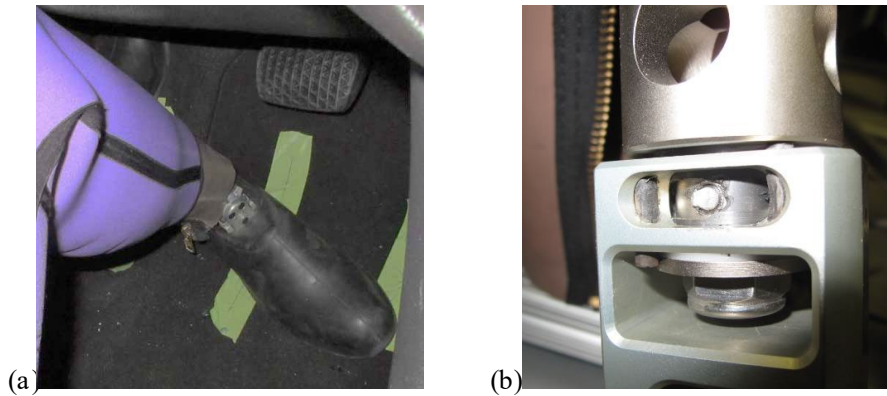

Figure 11. WorldSID-50M ankle damage as observed in both GMC Terrain tests, 11606 and 11611. (a) Right foot rotation about the z-axis, and (b) the sheared z-axis radial limit screw.

Loose Bolts

Difficulties encountered during qualification of both WorldSID-50M led to additional troubleshooting and inspection. In both instances, the primary difficulty was performing a passing thorax with arm test.

On WS-L1, the five bolts at the top of the spine box that secure the Upper Bracket Weldment – Spine Box to the spine box side plates were found to be loose. Tightening these bolts alleviated the issues preventing a passing qualification.

On WS-R, the bolts attaching the rubber lumbar spine to the lumbar mounting wedge were loose when the ATD was inspected following the initial qualification attempts. After tightening these bolts, the ATD was able to be qualified successfully.

Debris in Pelvis

There were multiple instances later in the test series where bits of glass and other debris were noted down inside of the pelvis of the WorldSID-50M. This debris was removed from the pelvis using a shop vacuum to prevent the debris from flying up and obstructing the LEDs and sensors of the RibEye System in subsequent tests.

Arm Flesh

Following the Ford Ranger pole test (test 11612), inspection of WS-L1 revealed that the flesh of the right arm had pulled away from the internal plastic structure at the top of the arm. It is unclear if this damage occurred during the impact event or during removal of the ATD from the vehicle following the test. Since this was the last planned test of the series with WS-L1, this was simply noted, and no further action was taken.

Crash Tests – General Rigor

To assess the degree to which the WorldSID-50M units were exposed to a rigorous testing series, ATD injury metrics were assessed after crash testing. Figure 12 indicates the proximity of observed injury metrics to baseline comparative values (Table 2). The coloration of the figure indicates the ratio of the respective WorldSID-50M injury metrics observed in this crash test series to EuroNCAP values:

Table 3. Coloration indicating the ratio of metrics to their comparative values.

Dark green:	<= 40%	
Light green:	> 40 and <= 60%	
Yellow:	> 60 and <= 80%	
Brown:	> 80 and <= 100%	
Red:	> 100%	

For example, of the nine pole tests, the HIC in four crashes was less than 40% (dark green) of the EuroNCAP reference value of 700. Four of the pole tests produced a HIC score between 41 – 60% (light green) of the EuroNCAP value, and the remaining pole tests produced a HIC score between 61 – 80% (gold) of the reference value.

Figure 12 displays the degree to which the various body regions of the WorldSID-50M were exposed to injurious conditions. In both crash configurations, each body region had at least a couple moderate-risk exposures. By considering Figure 12, it can be concluded that the pole tests were universally more injurious. While maximum thoracic rib deflection was the greatest injury metric in pole tests, the maximum lateral shoulder force was greatest in the MDB tests. In both crash configurations, the pubic symphysis lateral force yields a comparatively low injury metric to all others.

Despite numerous moderate- to high-risk crash test exposures, none of the WorldSID-50M sustained irreparable damage. Therefore, this crash test series demonstrates how the WorldSID-50M can sustain the rigors of current FMVSS No. 214 crash testing.

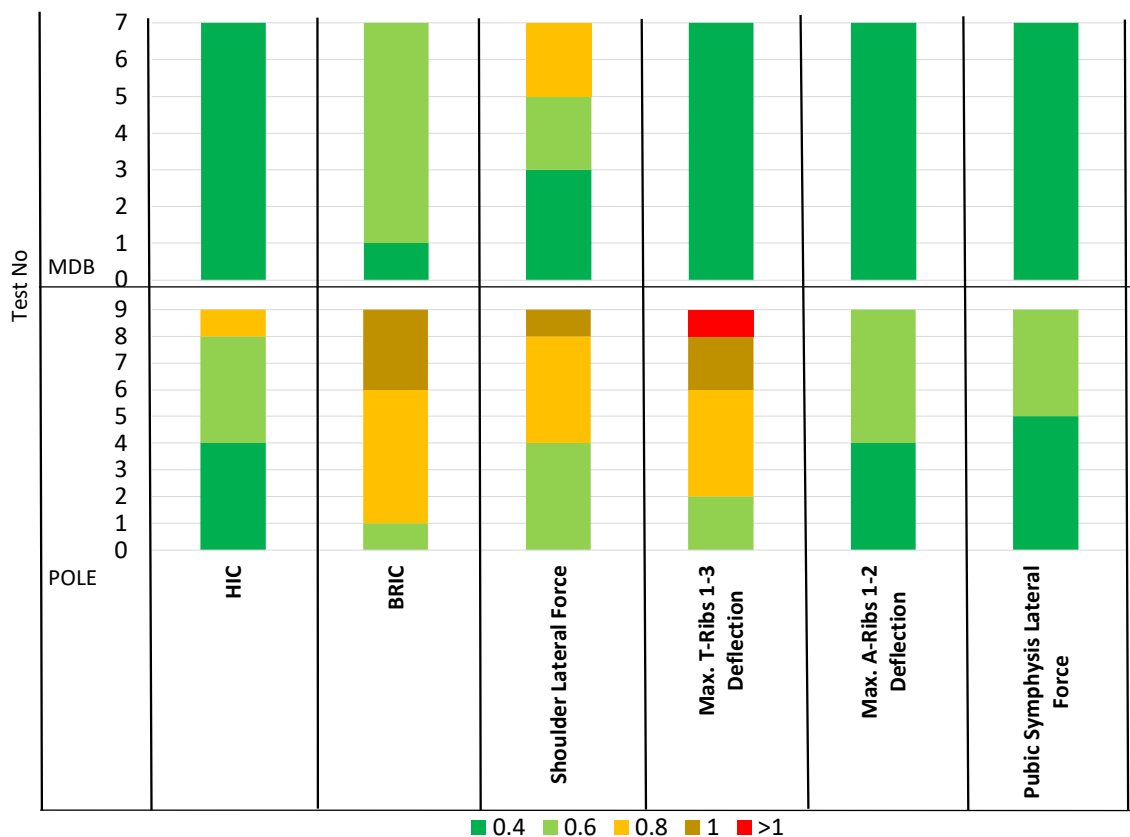

Figure 12. WorldSID-50M: Comparative injury metrics by exposure.

Crash Tests – RibEye Response

RibEye software measures the position of LEDs over time throughout a crash test event and computes rib deflections. It also displays error codes in the data when the sensors exhibit blockages, or an LED has moved out of range. Although most error codes observed in crash tests have been inconsequential and have not affected the ability of RibEye to measure maximum thorax and abdomen deflections, the error codes aid in understanding what might have caused sensor blockages if they occur.

MDB

Of the seven MDB tests performed in this series only two tests resulted in error codes - the Hyundai Santa Fe (11605) and the Mini Cooper S Convertible (11615). After analyzing the data, the error codes on these two tests were determined to be insignificant and neither affected the ability of RibEye to measure the maximum deflection of the thorax or abdomen ribs. Therefore, the maximum deflection of the thorax and abdomen ribs was successfully captured in all the MDB tests performed. The subsections below detail each of the scenarios causing the error codes that occurred in these MDB tests.

LED Traveled Out of Range

The front LED of the shoulder rib traveled out of range during the Mini Cooper S Convertible MDB test. Because the maximum shoulder rib deflection was able to be measured by the rear LED, the front LED going out of range was inconsequential.

Intermittent LED Power Connection

During the Hyundai Santa Fe MDB test, the middle LED on thorax rib 1 displayed an error code indicating this LED was blocked from all three sensors. Upon reviewing the data and inspecting the ATD, faulty connector pins were discovered in the connectors of the individual LED power circuits. Once the power connector and wire harness were replaced, there were no additional issues stemming from these power connections. Because the front LED on thorax rib 1 measured the maximum deflection on that rib (and for the thorax body region), the intermittent signal from the middle LED on thorax rib 1 was inconsequential.

Oblique Pole

There were two oblique pole tests where the RibEye system did not record any error codes, the Hyundai Veloster and the GMC Terrain. Of the nine tests where the RibEye system recorded error codes, the Mini Cooper S Convertible (11614) was the only test where measurement of the maximum deflection of the thorax and abdomen body regions was not obtained. Additionally, there was one test that resulted in a maximum shoulder deflection that could not be captured due to excessive shoulder rib movement. The subsections below detail each of the scenarios causing the error codes that occurred in these pole tests.

LED Traveled Out of Range

There were seven instances of LEDs travelling out of range during the pole tests. Six of these instances were recorded on the shoulder rib, which is not uncommon in the pole test condition where peak deflection is typically captured by the front or rear LED. When the front LED, for example, measures the maximum deflection of a rib, it is common for the rear LED on that rib to go out of range simply because its starting position is closer to the edge of the range toward which the rib is moving (Figure 13).

Of the six instances where an LED traveled out of range, only one resulted in the maximum shoulder deflection of the test not being captured. In the Chevrolet Malibu test (11600), the front LED of the shoulder rib went out of range. This location on the rib would have measured the maximum shoulder deflection. It is notable that the front LED had already measured 53 mm of deflection before it went out of range, so the shoulder was loaded substantially. The instance of a non-shoulder rib LED travelling out of range occurred in the Nissan Rogue test (11601). In this test, the front LED of thorax rib 1 travelled outside of the calibrated range, but the rear LED successfully captured maximum deflection, so this was inconsequential.

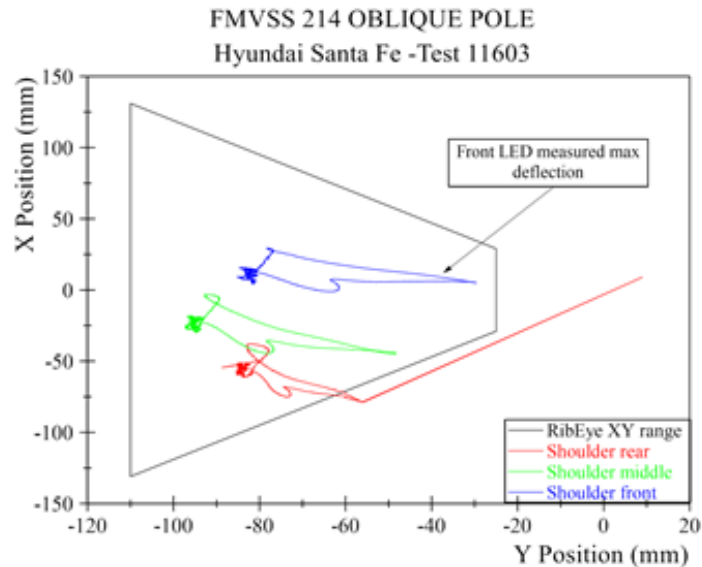

Figure 13. RibEye range plot for the Hyundai Santa Fe oblique pole crash test, 11603.

Intermittent LED Power Connection

Each of the first three pole tests recorded error codes indicating the thorax rib 2 front LED was blocked from all three sensors. Upon reviewing the data and inspecting the ATD, faulty connector pins were discovered in the connector of the LED power circuit. Once the LED and wire harness were replaced, there were no additional issues stemming from this power connection.

Thorax Rib 2 Blocked by Thorax Rib 1

There were five tests that recorded error codes indicating at least one LED on thorax rib 2 was blocked from the top sensor. These blockages were all caused by thorax rib 1 deflecting between the LED and the top sensor. This blockage is somewhat common but is inconsequential since this is an indication of thorax rib 1 having higher rib deflection than thorax rib 2 which rules out thorax rib 2 as possibly having the maximum overall rib deflection.

Thorax Rib 3 Blocked by Abdomen Rib 1

There were two tests that recorded error codes indicating an LED on thorax rib 3 was blocked from the bottom sensor. These blockages were both caused by abdomen rib 1 deflecting between the LED and the bottom sensor. Unlike thorax rib 1 blocking thorax rib 2, these blockages include ribs from both the thorax and abdomen body regions. In these two tests, thorax rib 3 would not have measured the maximum thorax deflection, so these blockages were inconsequential. However, if blocked LEDs on thorax rib 3 would have measured the maximum thorax deflection, then these blockages would have been consequential. In this test series, the maximum thorax and abdomen body region deflections were successfully captured regardless of these blockages.

Thorax Rib 1 Blocked by the Shoulder

During the Mini Cooper S Convertible pole test (11614), the shoulder rib traveled inward and downward a significant amount due to airbag and intrusion interactions. A still image from the crash test close to the point of maximum shoulder deflection is depicted in Figure 14. The shoulder rib displaced to the extent that it fully blocked the rear LED and partially blocked the middle LED of thorax rib 1 from the top sensor as shown via a CAD model rendering in Figure 15. If the thorax rib 1 LEDs had not been blocked, it would have measured the maximum thorax deflection. Therefore, this blockage prevented the maximum thorax deflection from being recorded. This is the only test, including all past NHTSA WorldSID-50M crash tests, where the maximum thorax body region deflection was not captured.



Figure 14. Still image of the WorldSID-50M from the 2019 Mini Cooper Convertible crash test (11614) showing ATD interaction with the combination head/torso airbag and intrusion which caused the arm, shoulder rib, and thorax ribs to experience similar loading.

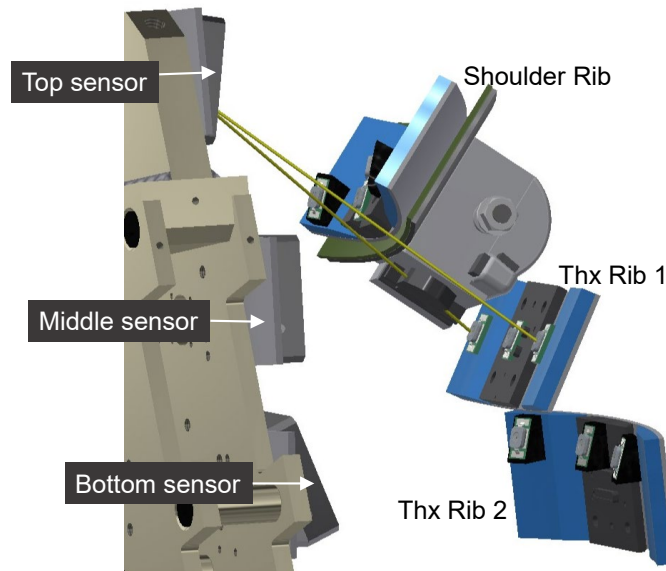

Figure 15. 3D CAD model of the rib motion during crash test 11614 in which the rear LED on thorax rib 1 is blocked by the shoulder rib. NOTE: Model is shown as a left side impact, but, the test was a right-side impact.

Relocation of RibEye LEDs

Relative to the other tests in this series, the Mini Cooper pole test (11614) yielded high shoulder rib deflection (60 mm), and it was this shoulder rib deflection that blocked the thorax rib 1 LEDs from the top sensor. With the LEDs of thorax rib 1 being blocked by the shoulder rib, it marks the first test where the maximum thorax deflection was not captured by the RibEye system, which raised concern regarding the possibility of this to occur in future crash testing.

In response, the 2019 Mini Cooper S convertible was retested in a pole condition with a WorldSID-50M that had updated LED locations. To allow more clearance from the rib above, and potentially prevent future LED blockages,

the LEDs on thorax rib 1 were relocated from the centerline of the rib to the bottom edge of the rib, and the middle LED was rotated to be oriented horizontally (Figure 16).

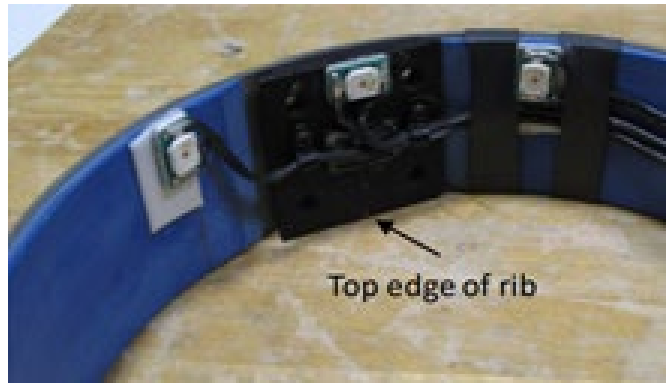

Figure 16. LEDs on thorax rib 1 of the WorldSID-50M after relocation from the centerline to the bottom edge where only the center LED is horizontally oriented.

Once this adjustment was made, test 11656 was conducted as a repeat of the right-side pole test on a 2019 Mini Cooper S convertible with the updated LED locations. An identical 2019 Mini Cooper Convertible was used with all the test setup parameters matching the previous test as closely as possible. Thorax rib 1 did not record any error codes in the repeat pole test, and the thorax rib 1 LEDs were clearly visible to the top sensor, as depicted in the below rendering (Figure 17). By overlaying the rib deflection data of these two tests, it was confirmed that the rib response was nearly identical. Therefore, it can be concluded that the relocation of the thorax rib 1 LEDs resolved the blockage that occurred in the first Mini Cooper test, and the maximum thorax deflection was successfully recorded in the repeat test.

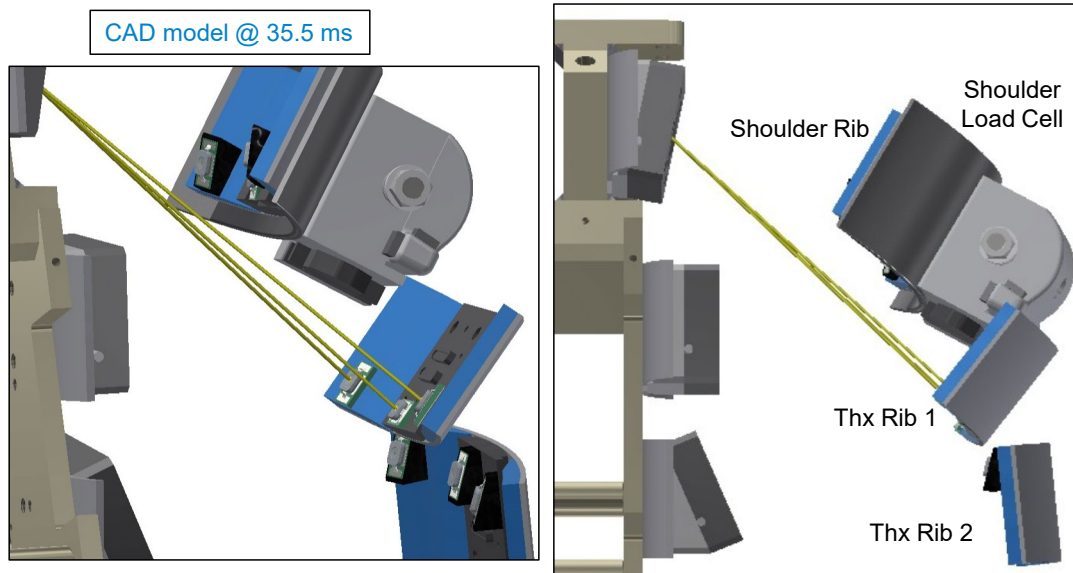

Figure 17. 3D CAD model of the rib motion during crash test 11656 in which the LEDs on thorax rib 1 are visible to the top sensor at maximum deflection.

After this test, the RibEye LED locations were further refined to allow for more deflection of the adjacent ribs where blockages might occur. In this iteration, the LEDs on both thorax rib 1 and abdomen rib 1 were moved to the bottom of the rib from center as depicted in Figure 18. The LEDs were also all rotated to be oriented horizontally rather than vertically. To evaluate these LED location adjustments, the 2020 Toyota Tacoma and 2020 Kia Soul were selected

as subsequent test vehicles based on their previous NCAP pole crash test performance. NCAP results on these vehicle models using the Side Impact Dummy (SID)-IIs showed elevated rib deflections and iliac forces.



Figure 18. LEDs on thorax rib 1 of the WorldSID-50M after relocation from the centerline to the bottom edge where all the LEDs are horizontally oriented (view is looking down onto the top of the rib).

In the tests of these vehicles – 14356 and 14355, respectively – the maximum deflection of the thorax and a abdomen body regions were recorded successfully. Relocation of the LEDs on thorax rib 1 and a abdomen rib 1 allowed for more clearance and movement of the shoulder rib and thorax rib 3 to prevent LED blockages. These results serve as preliminary validation of the RibEye LED relocations. More RibEye evaluation is underway to further support these updates.

LIMITATIONS

This study had minor limitations in that the vehicle fleet was limited. Few small, compact, and sub-compact size vehicles were included in this test series. Further, crash tests were only conducted at one lab. The updated RibEye LED placement was only utilized in three vehicle tests. In addition, the current IDDAS being evaluated is the DTS G5 which is older technology, and the older mini distributor yielded minor issues throughout this crash test series. A more up-to-date mini distributor model would allow for lower battery input voltage. Further, the TDAS Control software used in this test series has been superseded by DTS DataPro software.

CONCLUSIONS

In this crash series of FMVSS No. 214 MDB and oblique pole tests, the WorldSID-50M successfully completed the crash test series and was durable. Scripted procedures for WorldSID-50M assembly, qualification, and handling were followed without issue, and the seating procedures resulted in highly uniform positioning. The WorldSID-50M passed many qualification tests without an issue regarding the test setup or response specifications. The pelvis qualification test is an ongoing exception, due to evolving proposed specifications. The thorax with arm test yielded failures, but the results were in specification after tightening loose bolts in the upper and lumbar spine. Throughout the eighteen crash tests, the WorldSID-50M exhibited few sensor anomalies, all of which could be attributed to identifiable causes and were inconsequential. No major damage was observed in WorldSID-50M aside from a broken ankle rotation stop yielded from a single vehicle model. RibEye was durable and worked well, achieving maximum thorax and abdomen deflections in all but one test, which was subsequently remedied.

REFERENCES

- [1] Rhule, H., Moorhouse, K., Donnelly, B., & Stricklin, J. (2009). Comparison of WorldSID and ES-2re biofidelity using an updated biofidelity ranking system. Proceedings of the 19th International Technical Conference on the Enhanced Safety of Vehicles, Washington, DC, Paper Number 09-0563.
- [2] National Highway Traffic Safety Administration (2015). NCAP RFC, December 16, 2015, Regulations.gov Docket ID NHTSA-2015-0119-0001, available at: <https://www.regulations.gov/document/NHTSA-2015-0119-0001>
- [3] Rhule, D. A., & Stricklin, J. L. (2022, July). Evaluation of the WorldSID 50th percentile male side impact dummy – Qualification and sled test repeatability and reproducibility (Report No. DOT HS 813 214). National Highway Traffic Safety Administration.
- [4] Rhule, D., Millis, W., & Stricklin, J. (2022, January). WorldSID 50th percentile male durability assessment (Report No. DOT HS 813 212). Washington, DC: National Highway Traffic Safety Administration.
- [5] National Highway Traffic Safety Administration (2023). Evaluation of RibEye Installed in the WorldSID 50th Percentile Male Dummy. Washington, DC: *Undergoing final document proofing; publication scheduled for 2023.*
- [6] Loudon, A. E. (2019, April). WorldSID 50th percentile male dummy seating procedure evaluation and revision (Report No. DOT HS 812 694). Washington, DC: National Highway Traffic Safety Administration.
- [7] National Highway Traffic Safety Administration (2023). WorldSID-50M Procedures for Assembly, Disassembly, and Inspection (PADI), Washington, DC: *Undergoing final document proofing; publication scheduled for 2023.*
- [8] National Highway Traffic Safety Administration (2023). WorldSID-50M Procedures for Qualification. Washington, DC: *Undergoing final document proofing; publication scheduled for 2023.*
- [9] Rhule, H., Millis, W., Mallory, A., & Stricklin, J. (2019, July). Determination of optimal RibEye LED locations in the WorldSID 50th percentile male dummy (Report No. DOT HS 812 758). Washington, DC: National Highway Traffic Safety Administration.

APPENDIX

Table A-4 Qualification Summary of WS-L1.

Qualification Number	ATD Qualified	Start/End Dates	VRTC or TRC	Full or Partial	Additional Info
1	WS-L1	9/1/20-9/10/20	VRTC	Full Qual	No Issues
2	WS-L1	10/26/20-11/6/20	TRC	Full Qual	Noted shoulder rib stiffeners were deformed following previous crash test. Shoulder rib possibly deformed as well.
2a	WS-L1	10/29/20-11/10/20	TRC	Partial Qual Shldr, Thrx w/Arm	These tests were performed due to replacement of shoulder rib stiffeners and shoulder rib.
3	WS-L1	1/15/21-1/21/21	TRC	Full Qual	No Issues
4	WS-L1	2/23/21-2/25/21	TRC	Full Qual	Following this qual, it was determined to replace the LED set due to intermittent connections – ATD transferred to VRTC for LED swap (no tests performed at VRTC).
4a	WS-L1	3/8/21-3/10/21	TRC	Partial Qual Shldr, Thrx w/Arm, Thrx w/o Arm, Abdomen	Partial qual performed to verify LED replacements didn't affect ATD performance; had issues passing Thorax w/ Arm - after inspecting, it was determined that the plate that attaches to the top of the spine box was loose, tightened bolts and passed qualification
5	WS-L1	3/25/21-3/29/21	TRC	Full Qual	No Issues
6	WS-L1	4/14/21-4/20/21	TRC	Full Qual	No Issues

Table A-2 Qualification Summary of WS-L2.

Qualification Number	ATD Qualified	Start/End Dates	VRTC or TRC	Full or Partial	Additional Info
1	WS-L2	4/19/22-5/4/22	VRTC	Full Qual	No Issues
2	WS-L2	7/18/22-7/21/22	VRTC	Full Qual	No Issues

Table A-3 Qualification Summary of WS-R.

Qualification Number	ATD Qualified	Start/End Dates	VRTC or TRC	Full or Partial	Additional Info
1	WS-R	1/26/21-2/12/21	TRC	Full Qual	Thorax w/ and w/o Arm were failing. Suspected stiff ribs, returned to VRTC for investigation.
1a	WS-R	2/25/2021	VRTC	Thorax w/o Arm Only	Attempted 2 Thorax w/o Arm to confirm failing results from TRC. Following this, the 3 thorax ribs were replaced due to a suspicion of stiff thorax ribs.
1b	WS-R	3/11/21-3/15/21	TRC	Partial Qual Shldr, Thrx w/ Arm, Thrx w/o Arm	After replacing the 3 thorax ribs, ATD returned to TRC to get partial qual, validating results of the rib replacement. Thorax w/ Arm still wouldn't pass. ATD returned to VRTC for further investigation.
1c	WS-R	3/25/21-3/31/21	VRTC	Partial Qual Shldr, Thrx w/ Arm, Thrx w/o Arm, Abdomen	Further investigation: 4 screws that connect the lumbar mounting wedge to the rubber lumbar spine were found to be loose. After tightening and reassembly, this qual was performed to verify fix.
2	WS-R	5/4/21-5/10/21	TRC	Full Qual	After 3 attempts, could not get the pelvis test to pass. Accepted the results as is since this is a post-test qualification.
3	WS-R	8/3/21-9/9/21	VRTC	Full Qual	All body hits were performed due to the ATD being stripped down for instrumentation calibration. Pelvis impacts were performed while attempting to troubleshoot the pelvis issues. These tests were performed with a variety of lower body components swapped out. The pelvis was ultimately accepted as is with the failing qualifications to prevent significant delays with the crash test.
4	WS-R	9/29/21-10/5/21	TRC	Full Qual	Because this was a post-test qual, the lab only needed to perform 1 hit with passing inputs. Both lateral neck tests had low headform angular rate. Thorax with arm had low rib 2 def., and pelvis had both low pelvis accel and low pubic force.